



FOR OFFICIAL USE

--	--	--	--	--	--

National  
Qualifications  
2024

Mark

--

**X835/75/01**

**Graphic Communication**

THURSDAY, 16 MAY

9:00 AM – 11:00 AM



\* X 8 3 5 7 5 0 1 \*

Fill in these boxes and read what is printed below.

Full name of centre

--

Town

--

Forename(s)

--

Surname

--

Number of seat

--

Date of birth

Day

--	--

Month

--	--

Year

--	--

Scottish candidate number

--	--	--	--	--	--	--	--	--	--

**Total marks — 80**

Attempt ALL questions.

**You may use a calculator.**

All dimensions are in mm.

All technical sketches and drawings use third angle projection.

You may use rulers, compasses or trammels for measuring.

In all questions you may use sketches and annotations to support your answer if you wish.

Write your answers clearly in the spaces provided in this booklet. Additional space for answers is provided at the end of this booklet. If you use this space you must clearly identify the question number you are attempting.

Use **blue** or **black** ink.

Before leaving the examination room you must give this booklet to the Invigilator; if you do not, you may lose all the marks for this paper.



\* X 8 3 5 7 5 0 1 0 1 \*

Total marks — 80  
Attempt ALL questions

1. A 3D CAD rendered pictorial of the packaging and cutter for a new range of chocolate brownies is shown below.



1. (continued)

MARKS  
DO NOT  
WRITE IN  
THIS  
MARGIN

An orthographic drawing and a pictorial view of the outer sleeve are shown in the supplementary sheet for use with question 1 (a) (i), (ii) and (iv).

(a) (i) Identify the correct end elevation view by ticking (✓) a box below.

1

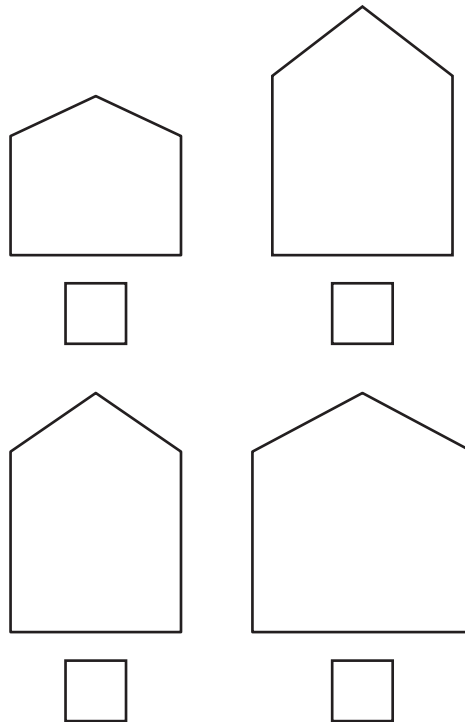

(ii) Identify the correct true shape of the sloping surface A-A by ticking (✓) a box below.

1

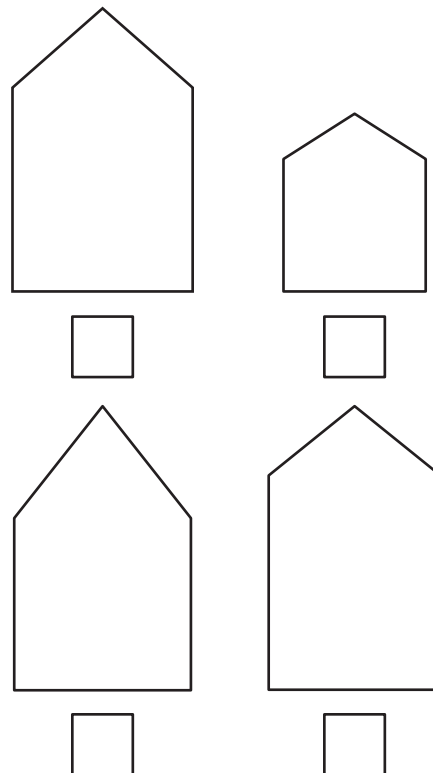

1. (a) (continued)

A pictorial view of the brownie box is shown below. The box is made of 5 panels with an open top.

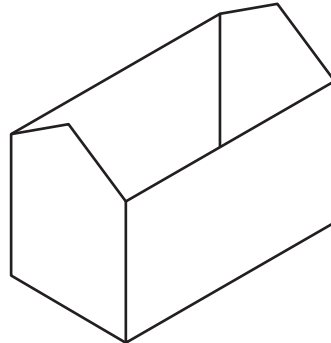

(iii) Identify the **two** correct brownie box surface developments by ticking (✓) two boxes below. Ignore wall thickness.

2

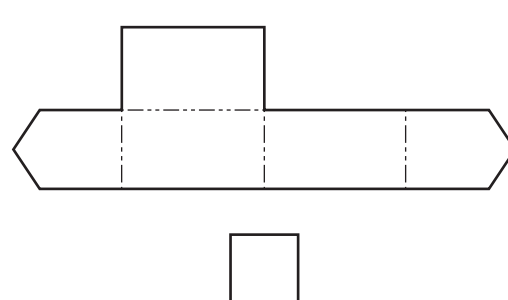
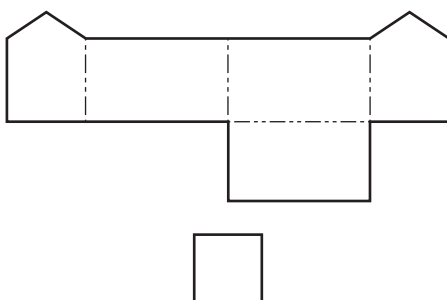
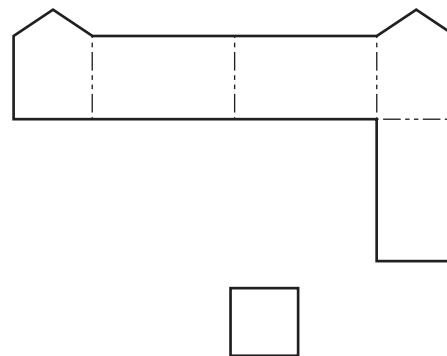
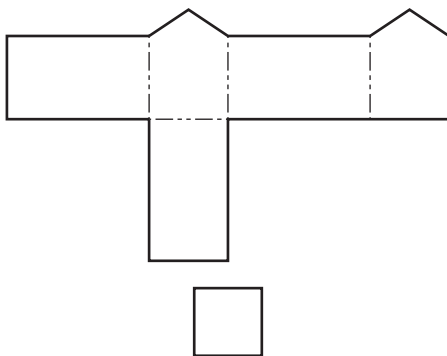
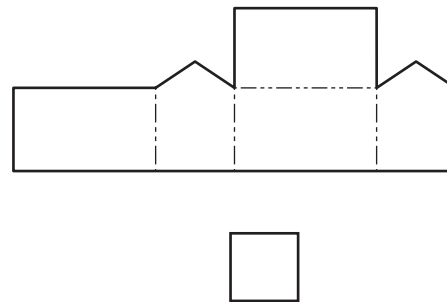
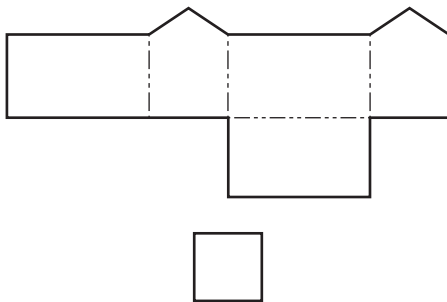

1. (a) (continued)

You should refer to supplementary sheet for use with question 1 (a) (iv).

- (iv) Identify the correct outer sleeve surface by ticking (✓) a box below. Ignore wall thickness.

1

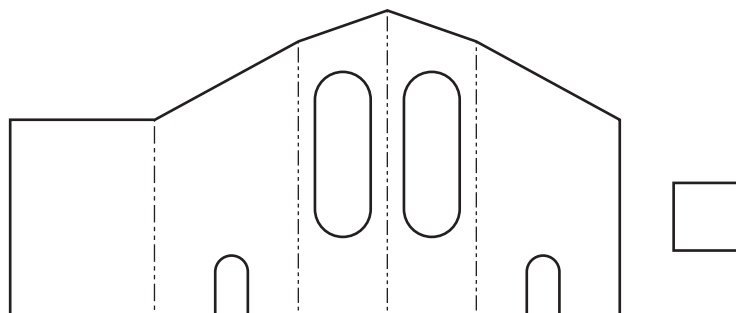
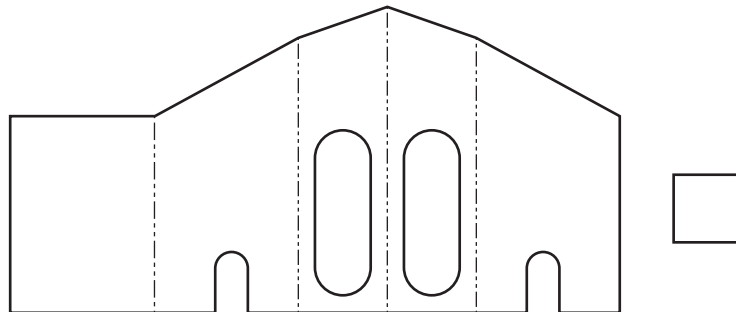
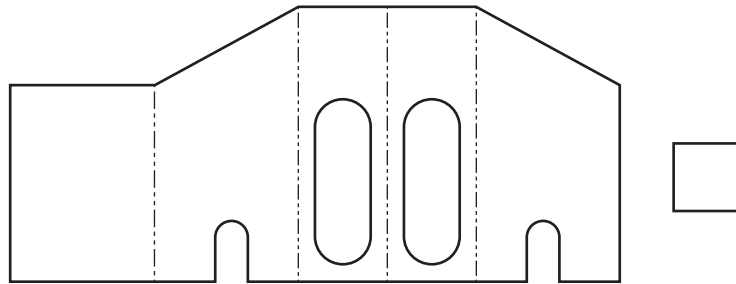
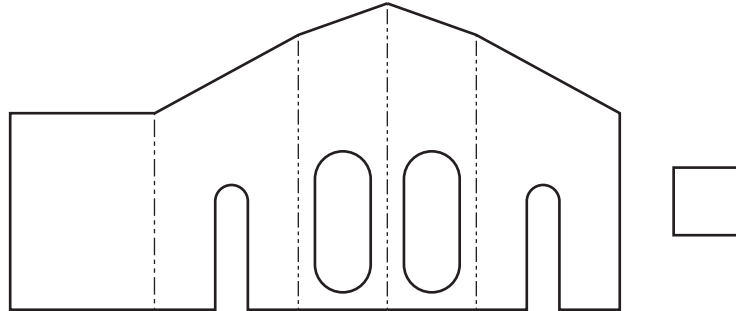

1. (continued)

An enlarged view taken from one of the surface developments is shown below.

(b) State the name of the line types shown:

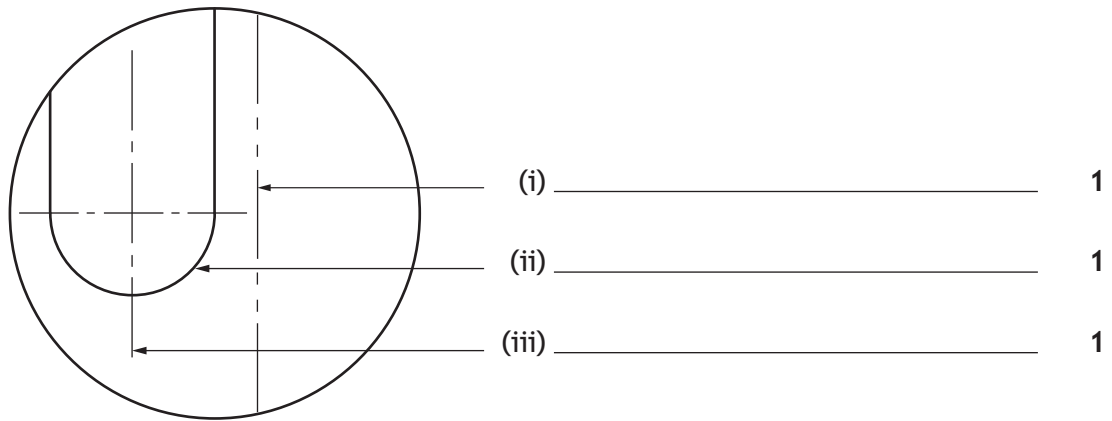

The enlarged view is created five times larger than the original object.

(c) State the scale used for the enlarged view. 1

\_\_\_\_\_

(d) Explain **two** ways the packaging can be made environmentally friendly. 2

\_\_\_\_\_

\_\_\_\_\_

\_\_\_\_\_

\_\_\_\_\_



1. (continued)

The cutter for the brownies is 3D printed.

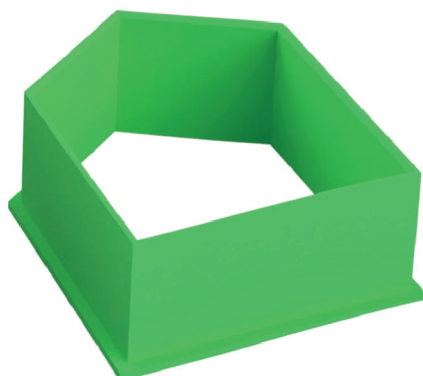

(e) State two advantages of 3D printing the cutter.

2

---

---

---

---

[Turn over



2. A rendered 3D CAD illustration of a stackable toy is shown below.



(a) State the name of two 3D CAD illustration techniques that have been applied to the stackable toy.

2

Technique 1 \_\_\_\_\_

Technique 2 \_\_\_\_\_



2. (continued)

An exploded view of the stackable toy is shown below.

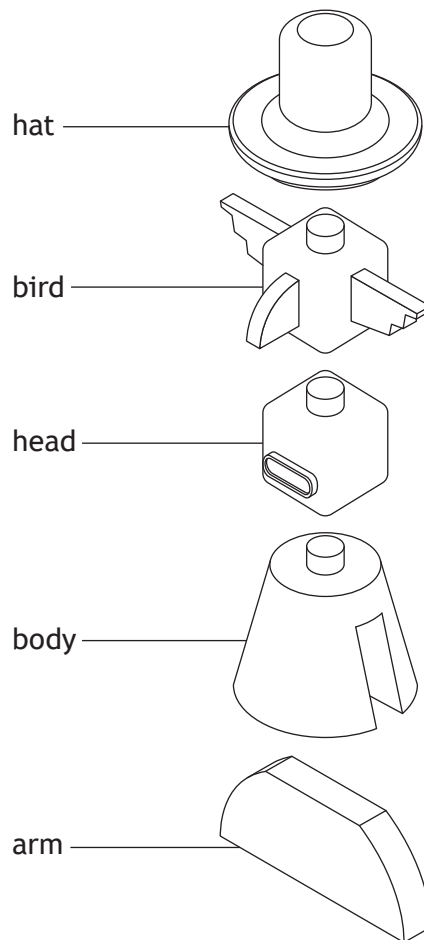

EXPLODED VIEW

(b) Describe **two** examples of good practice that have been applied when producing the exploded view, shown above.

2

---

---

---

---

[Turn over



2. (continued)

An orthographic drawing of the body component is shown below.

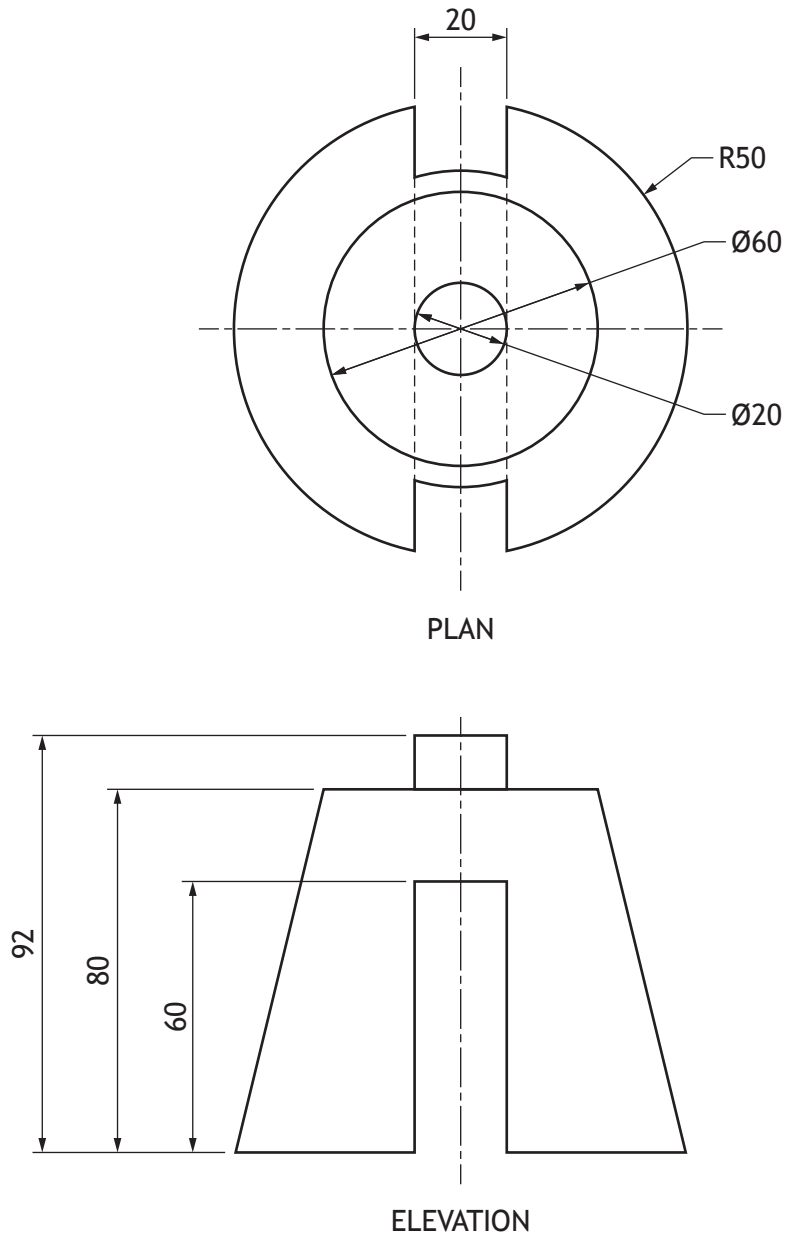

2. (continued)

- (c) Describe, using the correct dimensions and 3D CAD modelling terms, how you would use 3D CAD software to model the body.

4

You may use sketches to support your answer.

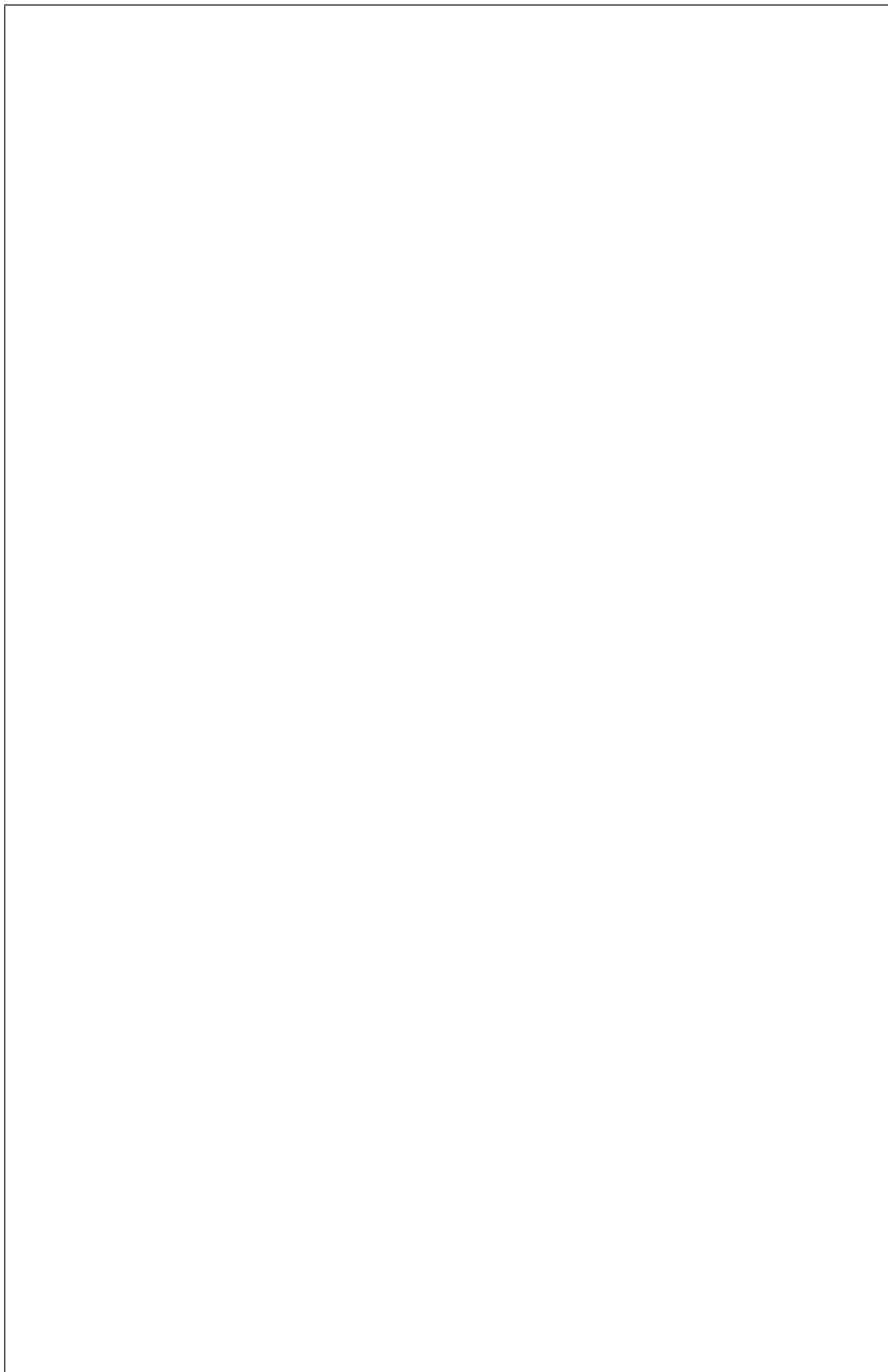

2. (continued)

3D CAD constraints were used to assemble the components of the stackable toy.

(d) Identify the 3D CAD constraint used at each stage.

You may sketch or annotate on the graphics to support your answer.

STAGE 1

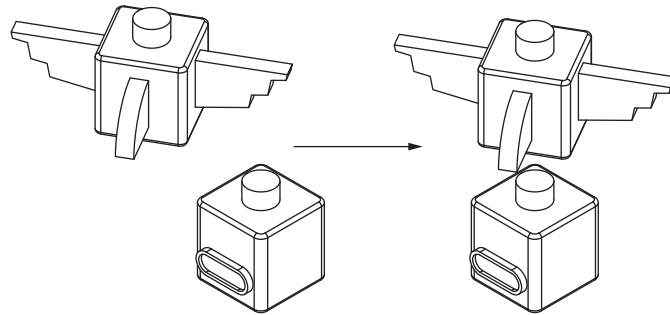

(i)

1

STAGE 2

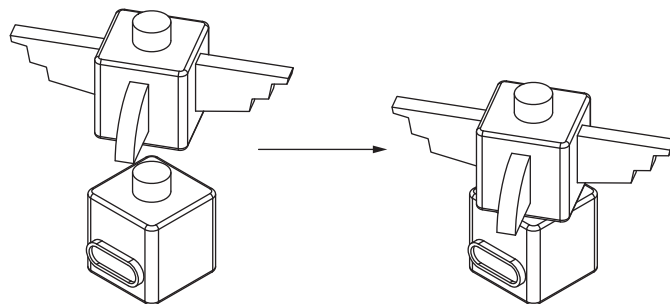

(ii)

1

STAGE 3

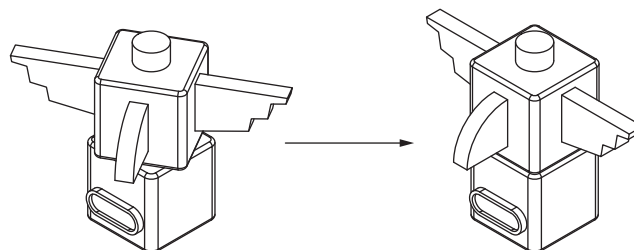

(iii)

1



2. (continued)

MARKS  
DO NOT  
WRITE IN  
THIS  
MARGIN

A rendered 3D CAD illustration of the bird component of the stackable toy is shown.

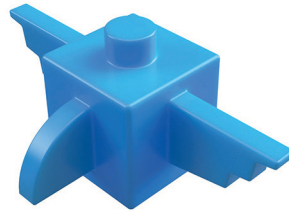

- (e) Describe, using the correct 3D CAD modelling techniques, how stages 2 and 3 of the 3D model are created.

You **do not** need to refer to dimensions in your answer. You may use sketches to support your answer.

Stage 1

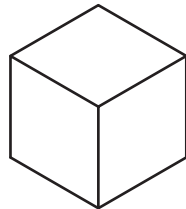

- (i) Stage 2

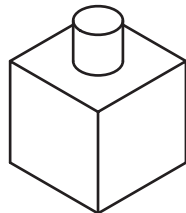

Blank area for describing Stage 2 modelling techniques.

2

- (ii) Stage 3

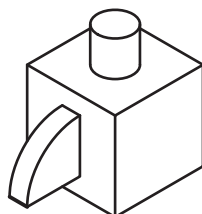

Blank area for describing Stage 3 modelling techniques.

3



2. (continued)

A dimensioned orthographic drawing of the bird component is shown below.

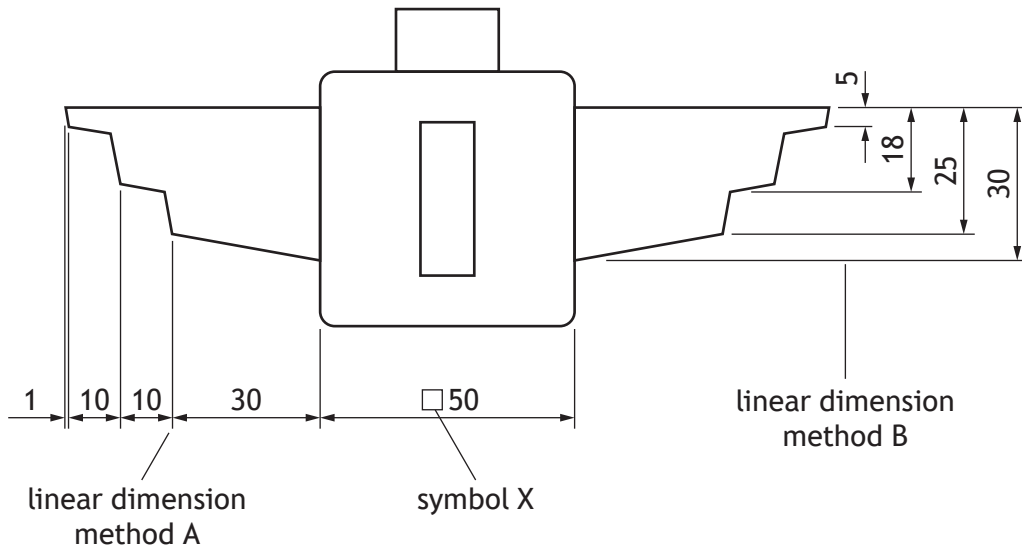

Different linear dimension methods have been used on the orthographic drawing.

(f) Identify the types of linear dimensions used above:

(i) Linear dimension method A \_\_\_\_\_ 1

(ii) Linear dimension method B \_\_\_\_\_ 1

(g) Explain the purpose of symbol X. 1

---



---



2. (continued)

An orthographic drawing of the hat component is shown below.

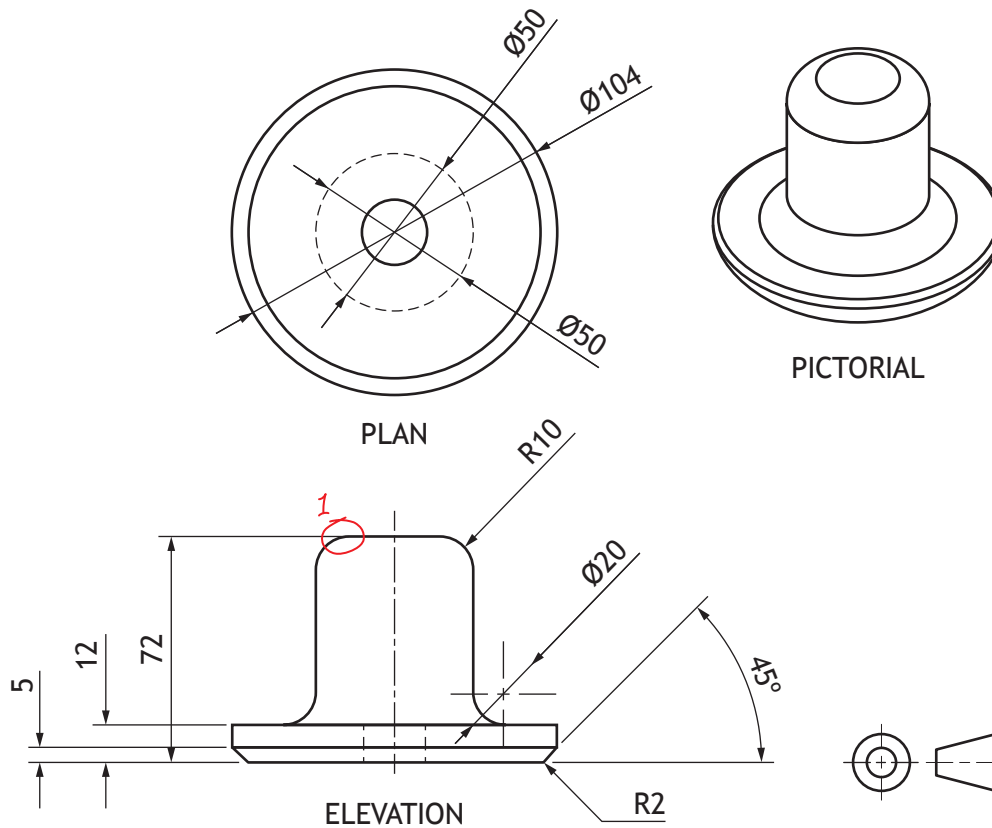

(h) Describe **four** errors in the orthographic drawing. An example has been completed for you.

You may annotate the orthographic drawing to support your answers.

Error 1: *Leader line touches view — there should be a gap.*

- (i) Error 2: \_\_\_\_\_ 1
- (ii) Error 3: \_\_\_\_\_ 1
- (iii) Error 4: \_\_\_\_\_ 1
- (iv) Error 5: \_\_\_\_\_ 1

[Turn over



2. (h) (continued)

- (v) 2D CAD tools were used to create the mouth feature on the head component.

State the name of the single 2D CAD tool used in each stage.

3

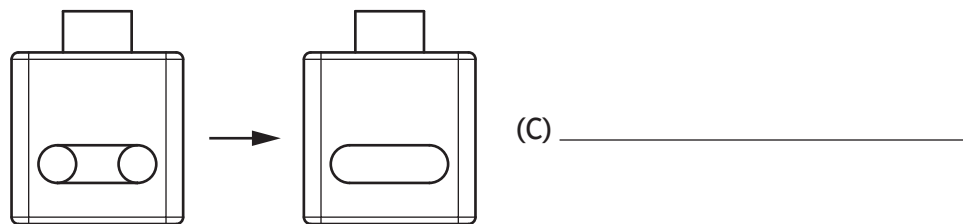
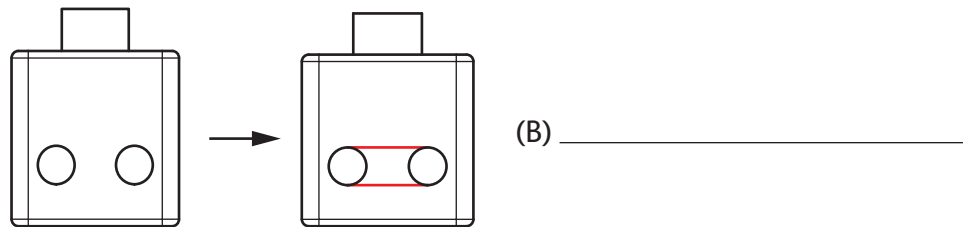
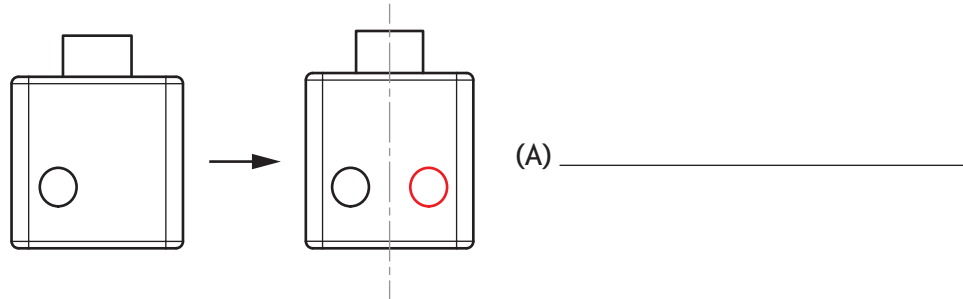

3. A promotional graphic for a website advertising a fitness tracker is shown below.



(a) Describe, giving **two** reasons, how the title STEP UP effects the layout. You must refer to design elements and principles in your answer.

2

---



---



---



---

(b) State the name of the desktop publishing technique used in the following elements of the promotional graphic:

(i) The text at A

1

---

(ii) The extended text at B

1

---

(iii) The shape at C

1

---

[Turn over



3. (continued)

(c) Explain why sans serif fonts were used in the promotional graphic.

1

---

---



(d) Describe four benefits of using DTP software to produce the fitness tracker promotional graphic. You must refer to features of the layout in your answer.

4

---

---

---

---

---

---

---

---

---

---



3. (continued)

- (e) Describe **three** additional features that can be added to an online publication that cannot be added to a printed publication.

3

---

---

---

---

---

---

---

[Turn over



\* X 8 3 5 7 5 0 1 1 9 \*

### 3. (continued)

Three screens showing the app on the fitness tracker are shown below.

The fitness app tracks a user's daily fitness progression (Screen 1), records step count across a week (Screen 2) and records sleeping patterns (Screen 3).



Screen 1



Screen 2



Screen 3



\* X 8 3 5 7 5 0 1 2 0 \*

3. (continued)

(f) (i) State the name of the graph used in **Screen 1**. 1

\_\_\_\_\_

(ii) Explain why this type of graph is appropriate for communicating this type of information. 1

\_\_\_\_\_  
\_\_\_\_\_

(g) (i) State the name of the graph used in **Screen 2**. 1

\_\_\_\_\_

(ii) Explain why this type of graph is appropriate for communicating this type of information. 1

\_\_\_\_\_  
\_\_\_\_\_

(h) (i) State the name of the graph used in **Screen 3**. 1

\_\_\_\_\_

(ii) Explain why this type of graph is appropriate for communicating this type of information. 1

\_\_\_\_\_  
\_\_\_\_\_

[Turn over



4. 3D CAD illustrations used to promote a lunch box are shown below.

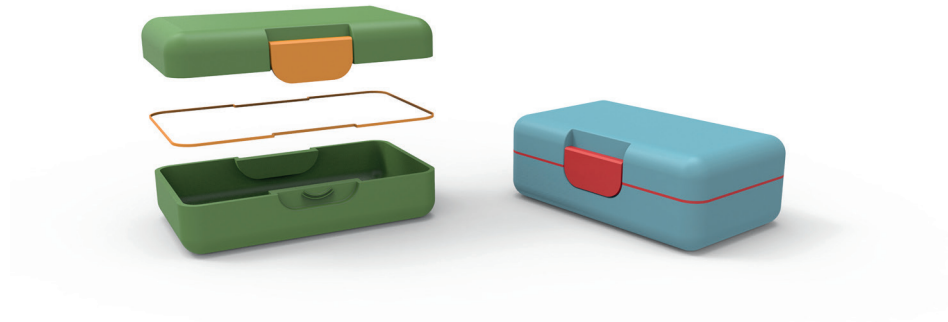

(a) Explain, giving **two** reasons, why the 3D CAD illustrations are suitable graphics to promote the lunch box.

2

---

---

---

---



4. (continued)

You must use the orthographic drawing provided in the supplementary sheet for use with question 4 (b).

- (b) Describe, using the correct dimensions and 3D CAD modelling terms, how you would use 3D CAD software to model the clip.

You may use sketches to support your answer.

5

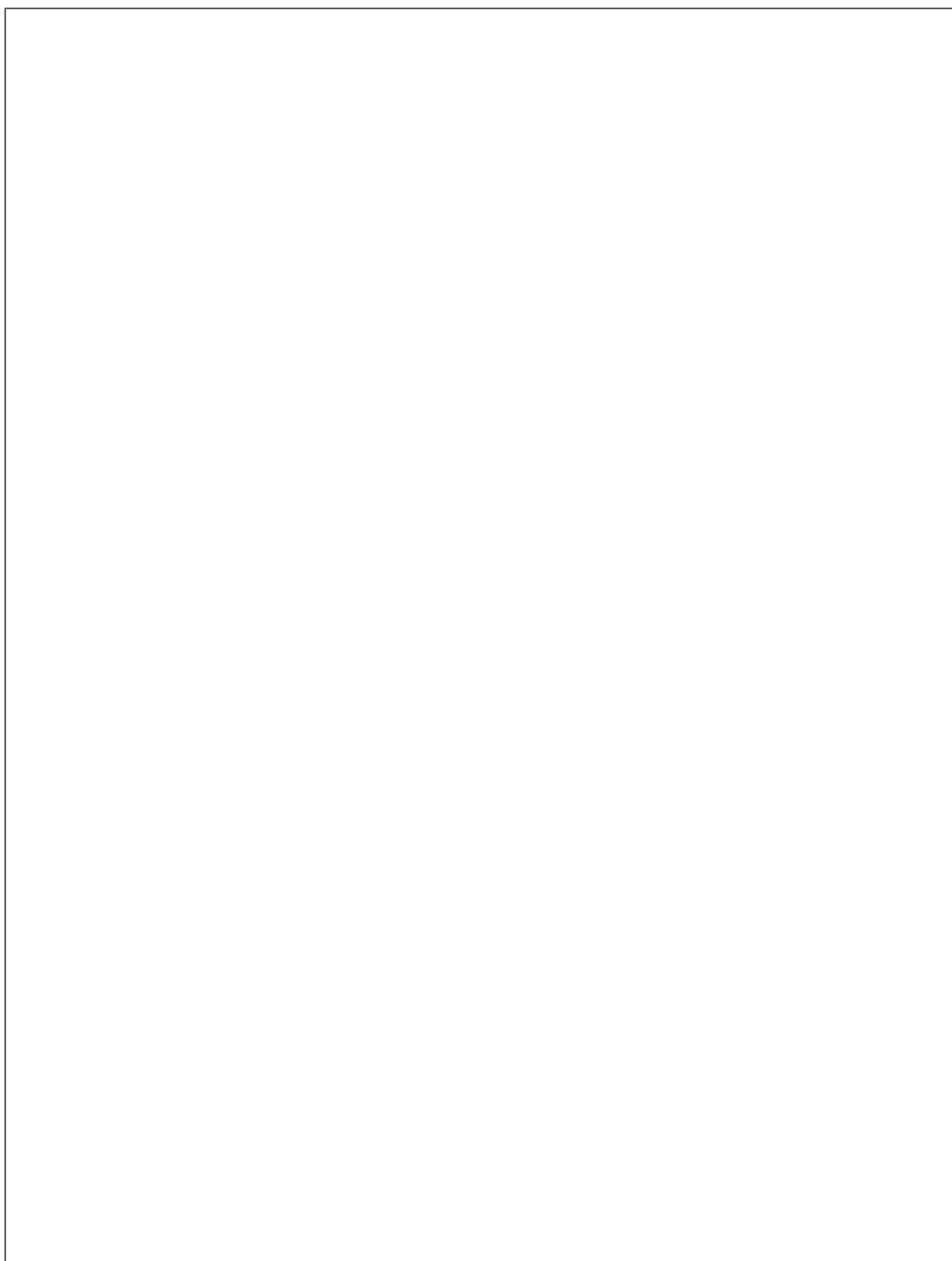

[Turn over



4. (continued)

A 3D CAD illustration of the lunch box, including its card sleeve packaging, is shown below.



The card sleeve includes a printed label with branding and some information about the lunch box, shown below.



\* X 8 3 5 7 5 0 1 2 4 \*

4. (continued)

(c) Describe **two** ways each of the design elements and principles, listed below, enhance the layout of the label.

(i) Depth

2

---

---

---

---

(ii) Unity

2

---

---

---

---

(iii) Alignment

2

---

---

---

---

(iv) Line

2

---

---

---

---

[Turn over



4. (continued)

You must use the orthographic drawing provided in the supplementary sheet for use with question 4 (d) and (e).

(d) Calculate the sizes circled on the orthographic drawing:

- |                  |   |
|------------------|---|
| (i) A _____ mm   | 1 |
| (ii) B _____ mm  | 1 |
| (iii) C _____ mm | 1 |
| (iv) D _____ mm  | 1 |
| (v) E _____ mm   | 1 |



4. (continued)

(e) Identify the two correct exploded pictorial drawings by ticking (✓) two boxes below.

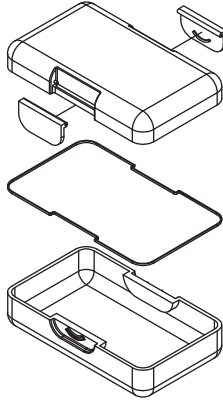

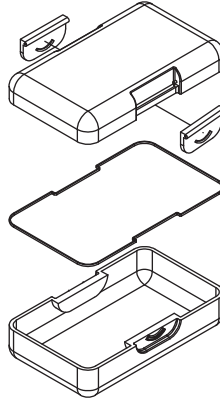

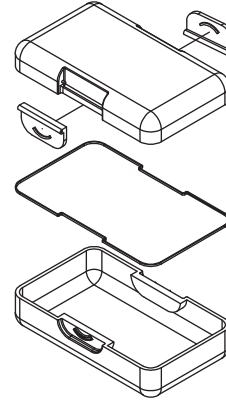

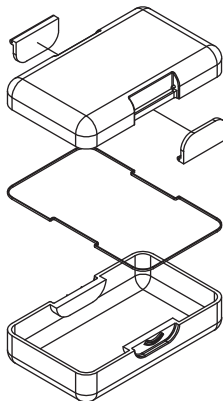

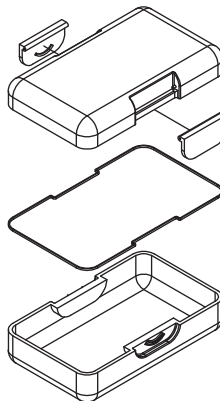

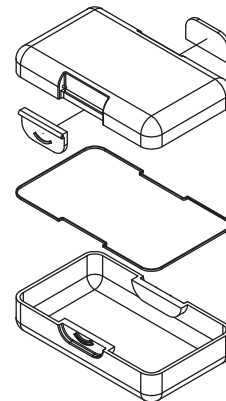



[END OF QUESTION PAPER]



\* X 8 3 5 7 5 0 1 2 7 \*

MARKS DO NOT  
WRITE IN  
THIS  
MARGIN

ADDITIONAL SPACE FOR ANSWERS



\* X 8 3 5 7 5 0 1 2 8 \*

MARKS DO NOT  
WRITE IN  
THIS  
MARGIN

ADDITIONAL SPACE FOR ANSWERS



\* X 8 3 5 7 5 0 1 2 9 \*

[BLANK PAGE]

DO NOT WRITE ON THIS PAGE



\* X 8 3 5 7 5 0 1 3 0 \*

[BLANK PAGE]

DO NOT WRITE ON THIS PAGE



\* X 8 3 5 7 5 0 1 3 1 \*

[BLANK PAGE]

DO NOT WRITE ON THIS PAGE



\* X 8 3 5 7 5 0 1 3 2 \*