

FOR OFFICIAL USE



--	--	--	--	--	--

National Qualifications

Mark

--

**X857/76/01**

**Physics  
Paper 2**

Duration — 2 hours 15 minutes



\* X 8 5 7 7 6 0 1 \*

Fill in these boxes and read what is printed below.

Full name of centre

--

Town

--

Forename(s)

--

Surname

--

Number of seat

--

Date of birth

Day

--	--

Month

--	--

Year

--	--

Scottish candidate number

--	--	--	--	--	--	--	--	--	--

**Total marks — 130**

Attempt ALL questions.

**You may use a calculator.**

Reference may be made to the data sheet on *page 02* of this booklet and to the relationships sheet X857/76/11.

Care should be taken to give an appropriate number of significant figures in the final answers to calculations.

Write your answers clearly in the spaces provided in this booklet. Additional space for answers and rough work is provided at the end of this booklet. If you use this space you must clearly identify the question number you are attempting. Any rough work must be written in this booklet. Score through your rough work when you have written your final copy.

Use **blue** or **black** ink.

Before leaving the examination room you must give this booklet to the Invigilator; if you do not, you may lose all the marks for this paper.



\* X 8 5 7 7 6 0 1 0 1 \*

Total marks — 130  
 Attempt ALL questions

1. A skier launches from a ramp. The skier leaves the ramp with a launch velocity of  $16.0 \text{ m s}^{-1}$  at  $42.0^\circ$  to the horizontal.

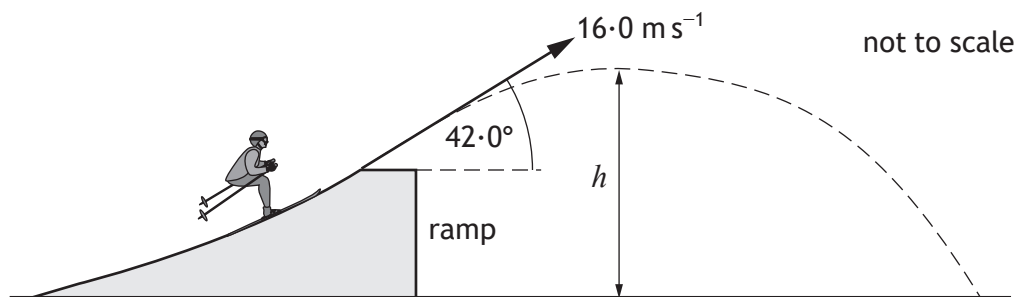

The effects of air resistance can be ignored.

(a) Calculate

- (i) the horizontal component of the launch velocity of the skier

1

*Space for working and answer*

- (ii) the vertical component of the launch velocity of the skier.

1

*Space for working and answer*



\* X 8 5 7 7 6 0 1 0 4 \*

1. (continued)

MARKS

DO NOT  
WRITE IN  
THIS  
MARGIN

- (b) Calculate the time taken for the skier to reach the maximum height  $h$  after launch.

3

*Space for working and answer*

- (c) The skier takes a further 1.40 s to travel from the maximum height  $h$  to the ground.

Determine the horizontal distance the skier travels from leaving the ramp until landing.

3

*Space for working and answer*

- (d) State how the value of the kinetic energy of the skier just before landing on the ground compares to their kinetic energy as they leave the ramp.

Justify your answer.

2



\* X 8 5 7 7 6 0 1 0 5 \*

2. A train consists of a steam engine coupled to a carriage. The train is accelerating along a straight level track.

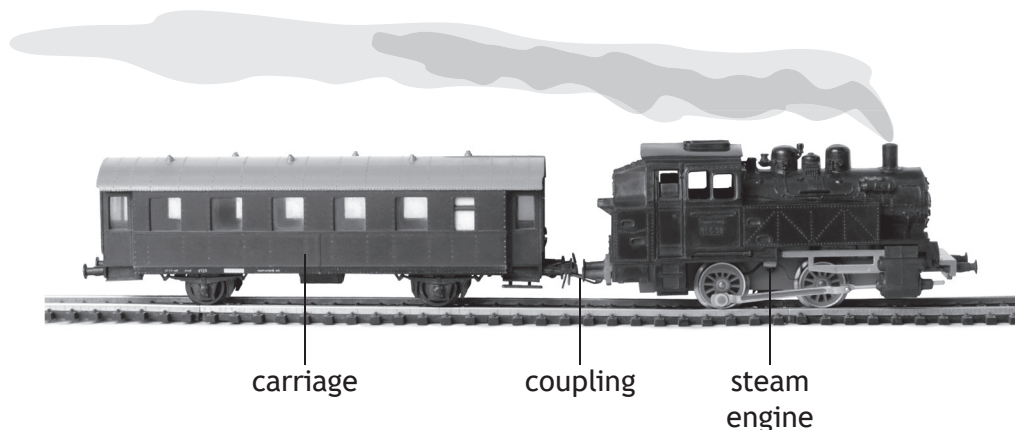

The steam engine provides a driving force of  $1.15 \times 10^5$  N.

The mass of the steam engine is  $9.75 \times 10^4$  kg.

The mass of the carriage and passengers is  $3.56 \times 10^4$  kg.

The effects of friction can be ignored.

- (a) Determine the tension in the coupling between the steam engine and the carriage.

4

*Space for working and answer*



2. (continued)

- (b) Later in the journey, the train is travelling at a constant speed as it approaches a bridge. Two students are standing on the bridge.

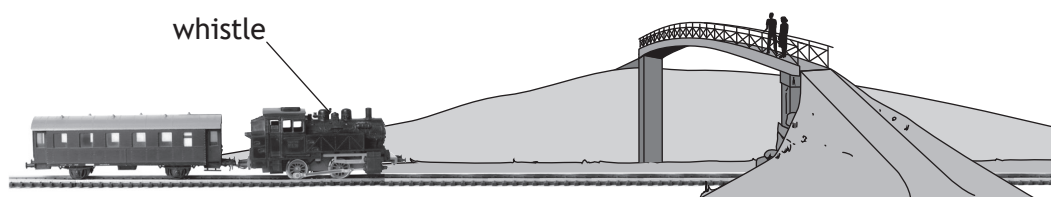

- (i) The engine driver sounds a whistle. The whistle emits sound with a frequency of 511 Hz.

The frequency of the sound heard by the students standing on the bridge is 531 Hz.

The speed of sound in air is  $340 \text{ m s}^{-1}$ .

Calculate the speed of the train.

3

*Space for working and answer*

- (ii) One student suggests that a passenger sitting in the carriage behind the engine will hear a lower frequency of sound than the frequency emitted by the whistle.

State whether the student is correct.

You must justify your answer.

2



\* X 8 5 7 7 6 0 1 0 7 \*

3. A manufacturer tests whether a Perspex lens will break during an impact. The lens is placed on a stand and a steel ball is dropped from rest onto the lens. The ball has a mass of  $1.59 \times 10^{-2}$  kg and is dropped from a height of 1.27 m above the lens.

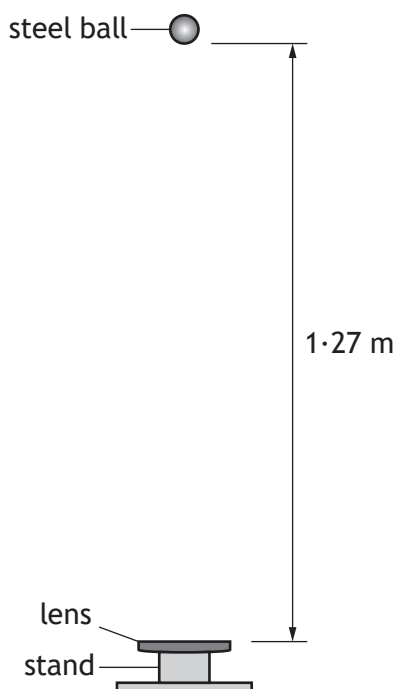

- (a) Calculate the speed of the ball as it reaches the lens.  
*Space for working and answer*

3



3. (continued)

- (b) The ball collides with the lens and rebounds upwards.

The magnitude of the change in momentum of the ball is  $0.14 \text{ kg m s}^{-1}$ .

Calculate the speed of the ball immediately after it rebounds from the lens.

3

*Space for working and answer*

- (c) The collision between the ball and the lens is inelastic.

Explain what is meant by an *inelastic collision*.

1

- (d) The test is repeated with a second lens made of a softer material.

Explain why this would make the lens less likely to break.

2



\* X 8 5 7 7 6 0 1 0 9 \*

4. A student finds the following diagram on a website. The website states that the diagram illustrates the evolution of the Universe from the Big Bang to the present day.

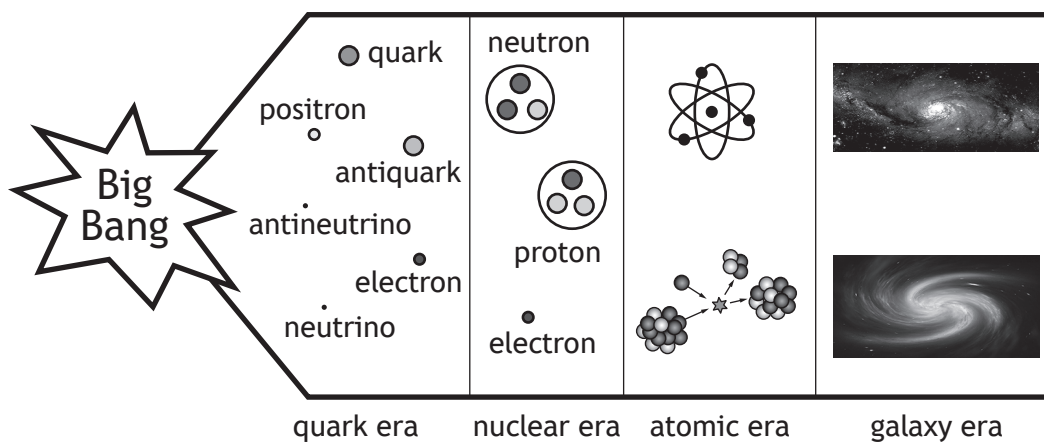

Using your knowledge of physics, comment on the diagram.

3



5. Astronomers have recently detected gravitational waves produced by the merging of two neutron stars.

An artist's illustration of two neutron stars merging is shown.

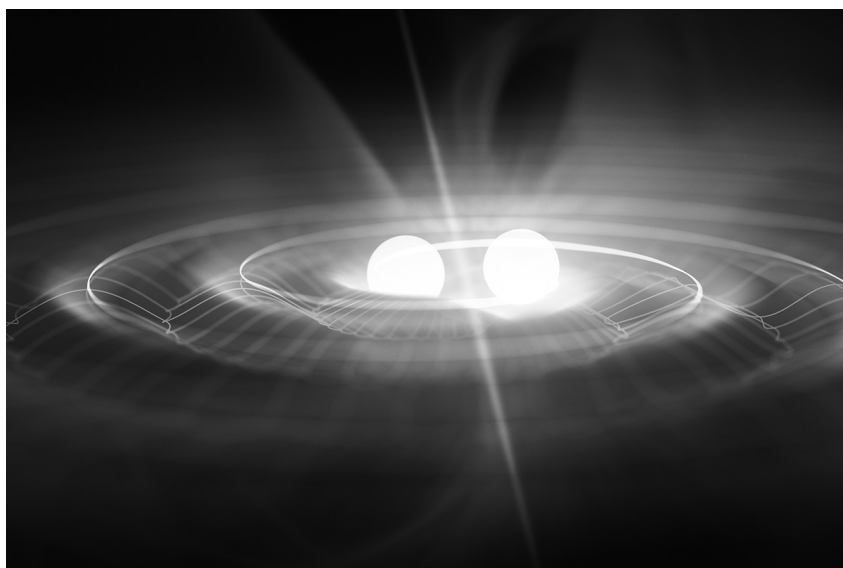

One of the neutron stars had a mass of  $3.18 \times 10^{30}$  kg.

The second neutron star had a mass of  $2.27 \times 10^{30}$  kg.

- (a) Calculate the separation of the neutron stars when the gravitational force of attraction between them was  $1.59 \times 10^{39}$  N.

3

*Space for working and answer*



5. (continued)

- (b) An interferometer is a device that can be used to detect gravitational waves.

In the interferometer, a beam of coherent light from a laser is split into two by a beam splitter.

The two beams then travel down the interferometer arms, reflect from mirrors, and finally meet to produce an interference pattern.

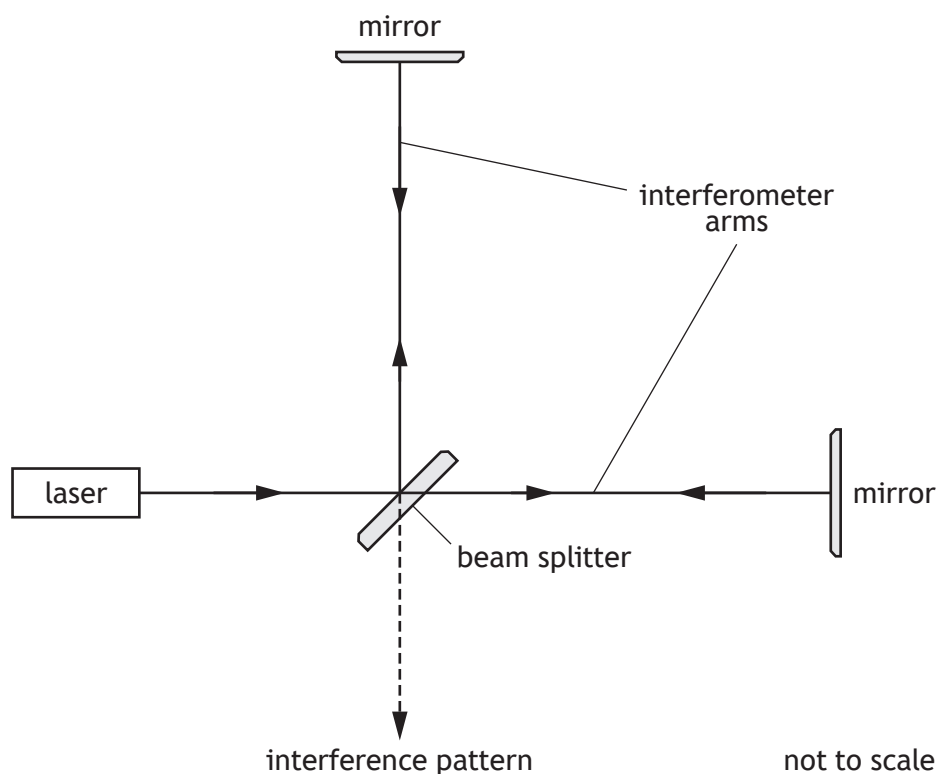

- (i) Explain, in terms of waves, how a minimum is formed in the interference pattern.

1

[Turn over



5. (b) (continued)

(ii) Each interferometer arm is 4.0 km long.

A gravitational wave changes the length of the arms, affecting the interference pattern produced.

The change in length of one of the arms is approximately  $4.0 \times 10^{-18}$  m.

In terms of orders of magnitude, compare the change in length of the interferometer arm with its original length.

2

*Space for working and answer*



\* X 8 5 7 7 6 0 1 1 4 \*

6. White light from the Sun is analysed to produce the following absorption spectrum.



The spectral lines are known as Fraunhofer lines.

- (a) Some Fraunhofer lines are produced by the transition of electrons between energy levels in hydrogen atoms.

Some of the energy levels of the hydrogen atom are shown.

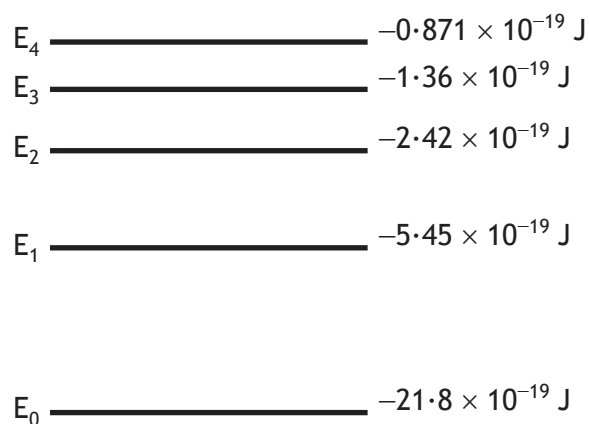

- (i) One of the Fraunhofer lines is due to the electron transition from  $E_1$  to  $E_4$ .

Determine the frequency of the photon absorbed when an electron makes this transition.

3

*Space for working and answer*



MARKS

DO NOT  
WRITE IN  
THIS  
MARGIN

6. (a) (continued)

(ii) Calculate the wavelength of the photon absorbed.

3

*Space for working and answer*

(iii) Determine the colour of the light absorbed during this electron transition.

1

[Turn over



\* X 8 5 7 7 6 0 1 1 7 \*

6. (continued)

- (b) The spectral lines observed in the spectrum from a distant galaxy are redshifted. A galaxy known as NGC 6745 has a recessional velocity of  $4.51 \times 10^6 \text{ m s}^{-1}$ .

Calculate the redshift of the light from this galaxy.

3

*Space for working and answer*

- (c) The light from the majority of galaxies in the Universe is redshifted. Explain how this evidence supports the Big Bang theory.

2



\* X 8 5 7 7 6 0 1 1 8 \*

7. The Large Hadron Collider (LHC) at CERN has been upgraded recently. One of the upgrades is the addition of a linear particle accelerator known as Linac4.

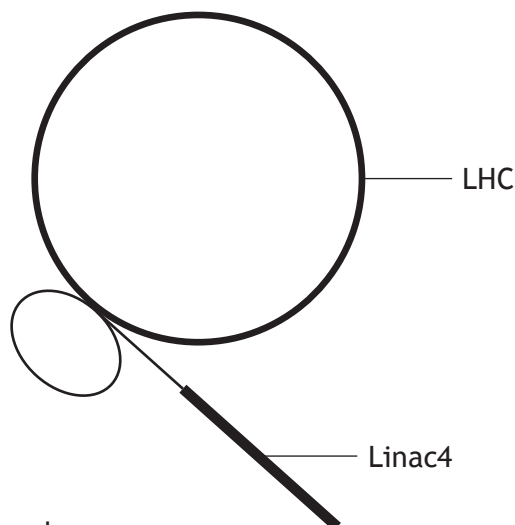

not to scale

Linac4 accelerates hydrogen ions before they enter the main LHC.

Linac4 consists of hollow metal tubes placed in a vacuum. The hydrogen ions are accelerated across the gaps between the tubes.

Part of Linac4 is shown below.

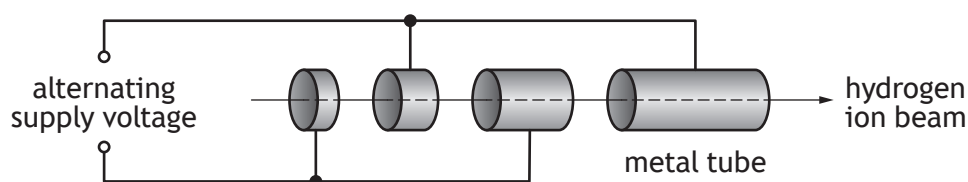

- (a) (i) Explain why an alternating supply voltage is used in Linac4. 1

- (ii) Suggest one reason why the lengths of the tubes increase along Linac4. 1

[Turn over



7. (continued)

MARKS  
DO NOT  
WRITE IN  
THIS  
MARGIN

- (b) Linac4 accelerates the hydrogen ions to a speed of  $0.50c$ . The hydrogen ions then travel through a connecting tube before entering the LHC.

The connecting tube has a length of 13 m in the frame of reference of a stationary observer.

Calculate the length of the connecting tube in the frame of reference of the hydrogen ions.

3

*Space for working and answer*

- (c) Hydrogen ions can be collided within the LHC to produce other particles.

One of the particles produced is known as a  $\pi^-$  meson. The  $\pi^-$  meson is negatively charged.

- (i) State what is meant by the term *meson*.

1

- (ii) The  $\pi^-$  meson enters a region of magnetic field and follows the path shown.

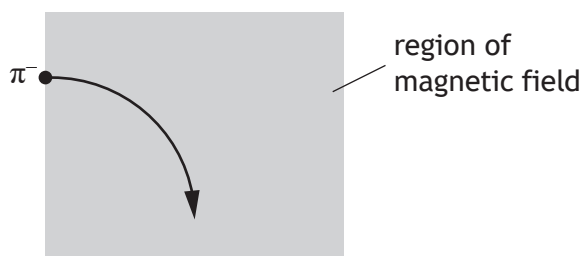

Determine the direction of the magnetic field acting upon the  $\pi^-$  meson.

1



7. (continued)

(d) In July 2018, scientists at CERN announced that the Higgs boson had been observed to decay into two bottom quarks.

(i) One of the fundamental forces involved in the decay of the Higgs boson is the weak nuclear force.

Name a force mediating particle for the weak nuclear force.

1

(ii) A bottom quark has a mass-energy equivalence of 4.20 GeV.

(1 eV =  $1.60 \times 10^{-19}$  J)

Determine the mass of the bottom quark.

4

*Space for working and answer*



\* X 8 5 7 7 6 0 1 2 1 \*

8. A student investigates the photoelectric effect using the apparatus shown.

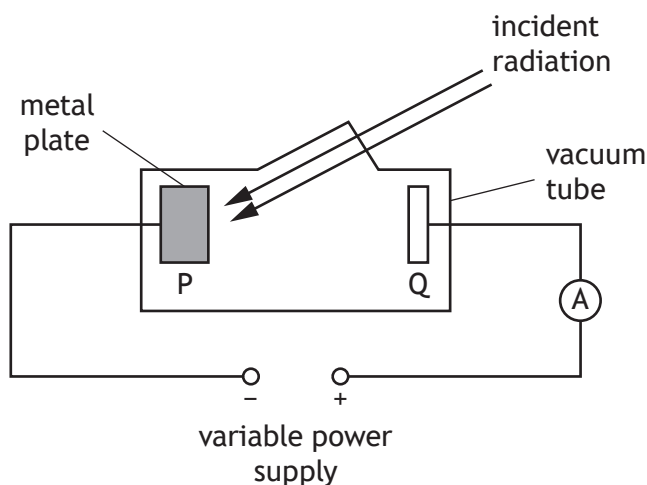

The student notices that when white light is incident on metal plate P, the reading on the ammeter is 0 A. However, when ultraviolet radiation is incident on plate P, the reading on the ammeter is greater than 0 A.

(a) Explain why ultraviolet radiation produces a reading greater than 0 A on the ammeter, but white light does not. 1

(b) The energy of a photon of ultraviolet radiation incident on plate P is  $8.0 \times 10^{-19}$  J.

The work function of the metal is  $6.9 \times 10^{-19}$  J.

The power supply is set to 12.0 V.

(i) Determine the maximum kinetic energy of an electron ejected from the surface of metal plate P. 1

*Space for working and answer*



MARKS

DO NOT  
WRITE IN  
THIS  
MARGIN

8. (b) (continued)

- (ii) Show that the kinetic energy gained by the electron as it accelerates from plate P to plate Q is  $1.92 \times 10^{-18}$  J.

2

*Space for working and answer*

- (iii) Determine the maximum speed of this electron as it reaches plate Q.

4

*Space for working and answer*



\* X 8 5 7 7 6 0 1 2 3 \*

9. Dental braces are used to adjust the position of a patient's teeth.  
Bonding cement is used to attach brackets to each tooth and then a stainless steel wire is attached to the brackets.

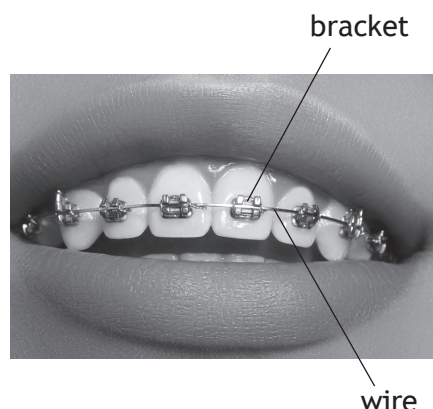

- (a) The tension in the wire exerts two forces to move one of the patient's front teeth backward.  
Both forces are 19.5 N as shown.

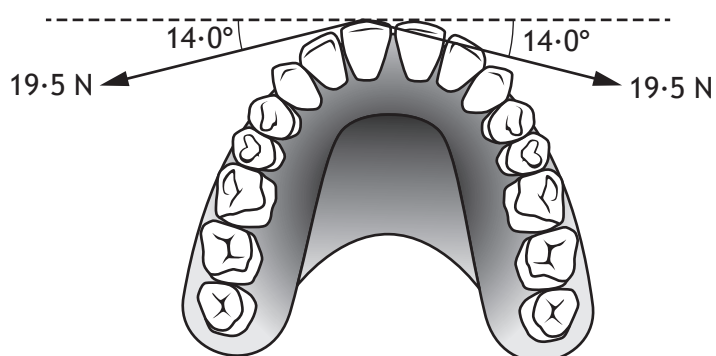

- (i) Determine the magnitude of the resultant force applied to the tooth.  
*Space for working and answer*

2

- (ii) Explain why the wire does not cause the tooth to move sideways.

1



9. (continued)

MARKS  
DO NOT  
WRITE IN  
THIS  
MARGIN

(b) Light from an LED is used to harden the bonding cement applied to the patient's teeth.

(i) The irradiance of the light from the LED on the cement on one tooth is  $11\,800\text{ W m}^{-2}$ .

The bonding cement on this tooth has an area of  $1.24 \times 10^{-5}\text{ m}^2$ .

The cement requires  $2.10\text{ J}$  of energy to harden.

Determine the minimum time for which the light from the LED must be applied.

5

*Space for working and answer*



\* X 8 5 7 7 6 0 1 2 5 \*

9. (b) (continued)

- (ii) Concern has been raised about the effect the light from the LED may have upon dental assistants' eyes.

A medical researcher investigates how the irradiance  $I$  varies with distance  $d$  from the LED.

The following results are obtained.

$d$ (m)	0.30	0.40	0.50	0.60
$I$ ( $\text{W m}^{-2}$ )	6.3	3.5	2.3	1.6

Use **all the data** to show that the LED acts as a point source over this range.

3



\* X 8 5 7 7 6 0 1 2 6 \*

9. (b) (continued)

(iii) The LED is made from doped semiconductor material to create a p-n junction.

The diagram represents the band structure of the LED.

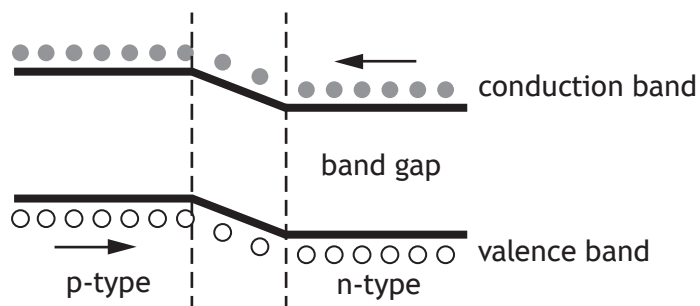

(A) State what is meant by a *doped semiconductor*.

1

(B) A voltage is applied across the LED so that it is forward biased and emits light.

Using **band theory**, explain how the LED emits light.

3



\* X 8 5 7 7 6 0 1 2 7 \*

10. A technician carries out an experiment to determine the wavelength of monochromatic light from a laser.

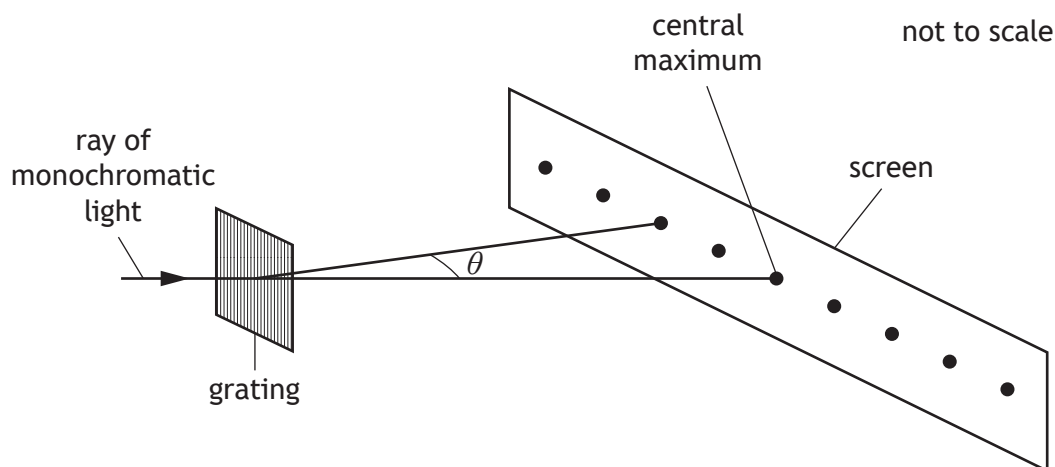

- (a) A pattern of bright spots is observed on the screen.

The technician measures the angle  $\theta$  between the central maximum and the second order maximum five times.

The results are shown.

14.0°      13.5°      14.5°      14.5°      13.0°

- (i) Calculate

- (A) the mean value for the angle  $\theta$

1

*Space for working and answer*

- (B) the approximate random uncertainty in this value.

2

*Space for working and answer*



\* X 8 5 7 7 6 0 1 2 8 \*

10. (a) (continued)

- (ii) The spacing between the lines on the grating is  $4.00 \times 10^{-6}$  m.  
Calculate the wavelength of the light from the laser.

3

*Space for working and answer*

- (iii) The technician repeats the experiment and this time measures the angle between the central maximum and the third order maximum.

Explain why this gives a more precise value for the wavelength of the light.

1

- (b) The laser is now replaced by a source of white light. The pattern observed on the screen consists of a white central maximum and a series of continuous spectra on each side of the white central maximum.

Explain, in terms of path difference, why the central maximum is white.

1

[Turn over



\* X 8 5 7 7 6 0 1 2 9 \*

11. The use of analogies from everyday life can help people to better understand physics concepts.

The arrangement of books on the shelves of a bookcase can be used as an analogy for the Bohr model of the atom.



Using your knowledge of physics, comment on this analogy.

3



\* X 8 5 7 7 6 0 1 3 0 \*

12. A technician fills a hollow prism with a sugar solution. The technician shines red light from a laser into the prism. The angle through which the light refracts depends upon the concentration of the sugar solution.

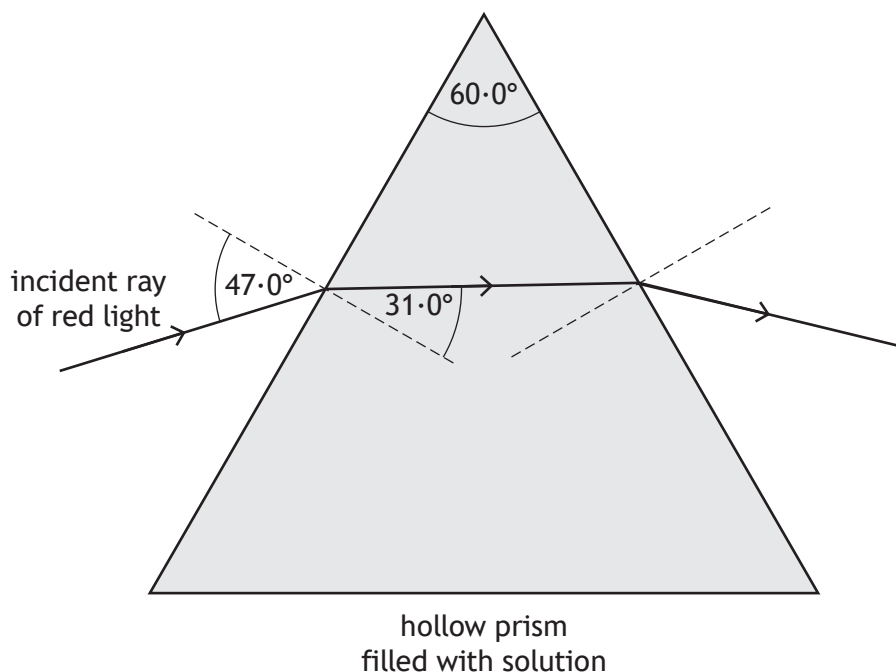

- (a) (i) Calculate the refractive index of this solution.

3

*Space for working and answer*

- (ii) State how the frequency of the light in the solution compares to the frequency of the light in air.

1



\* X 8 5 7 7 6 0 1 3 2 \*

12. (continued)

- (b) The prism is now filled with a more concentrated sugar solution, which has a greater refractive index.

On the diagram below, draw the path the ray will now follow **inside** the prism.

1

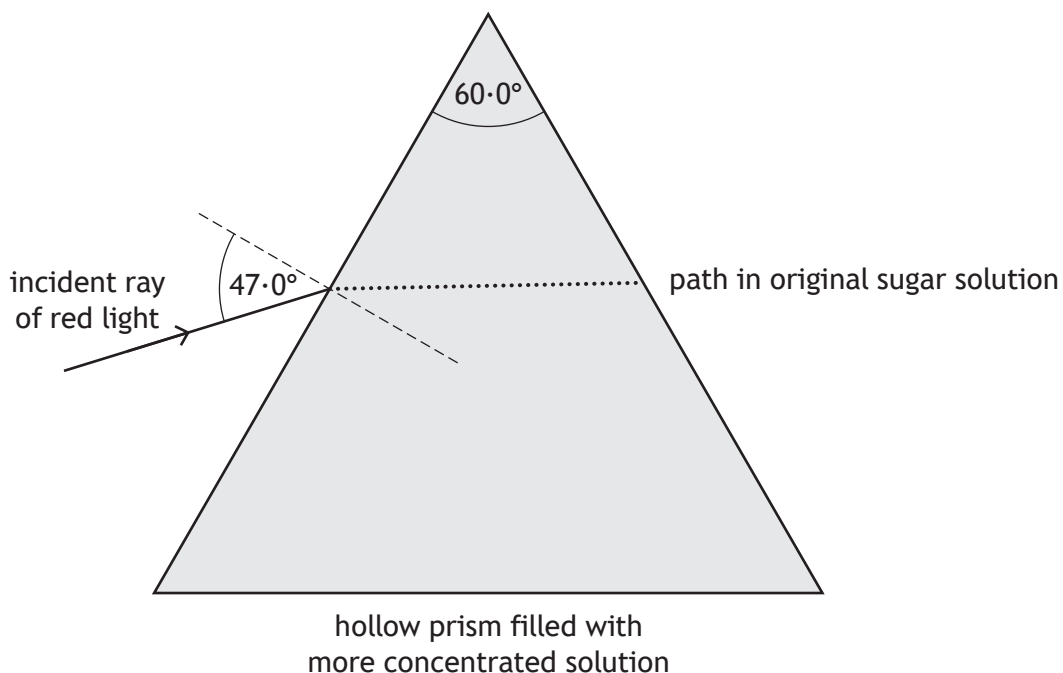

(An additional diagram, if required can be found on *page 45*.)

- (c) The experiment is repeated using green light from a laser and the more concentrated sugar solution. The light enters the prism at the same angle as before.

Explain the difference in the path taken by the green light compared to the path taken by the red light.

2

[Turn over



13. A student connects a signal generator, which provides an alternating current, to an oscilloscope.



- (a) State what is meant by an *alternating current*.

1

- (b) The oscilloscope screen shows the output of the signal generator.

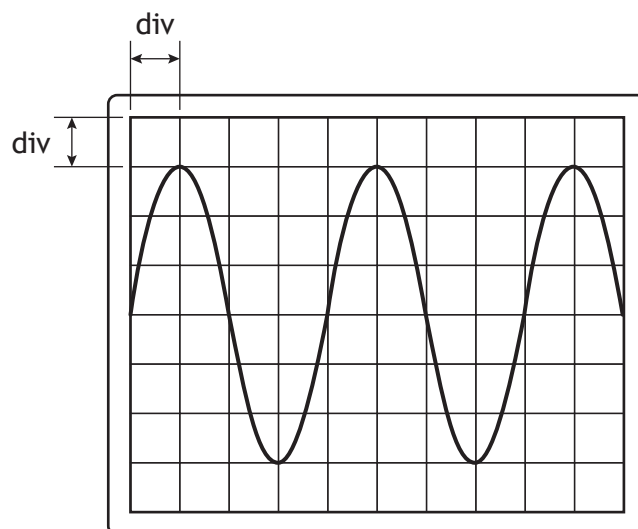

The Y-gain setting on the oscilloscope is 5.0 V/div.

The timebase setting on the oscilloscope is 1.0 ms/div.

- (i) Determine the peak voltage of the output of the signal generator.

1

*Space for working and answer*



\* X 8 5 7 7 6 0 1 3 4 \*

13. (b) (continued)

(ii) Determine the frequency of the output of the signal generator. 3

*Space for working and answer*

(c) The student connects a diode to the circuit as shown. The settings on the signal generator and the oscilloscope are unchanged.

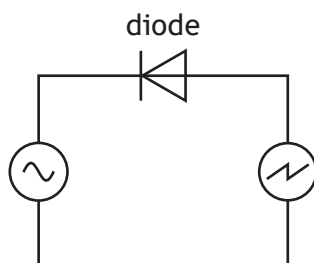

Current can only flow in one direction through a diode.

This changes the trace on the oscilloscope screen.

On the diagram below, draw the new trace seen on the oscilloscope screen. 2

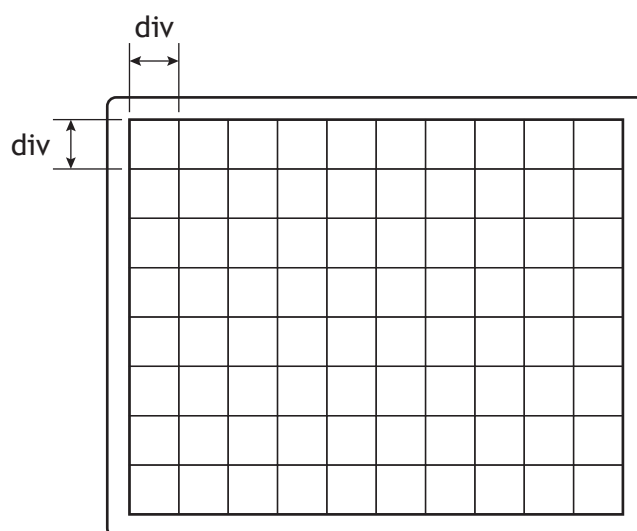

(An additional diagram, if required can be found on page 45.)



14. A student carries out an experiment, using the apparatus shown, to determine a value for the internal resistance  $r$  of a cell.

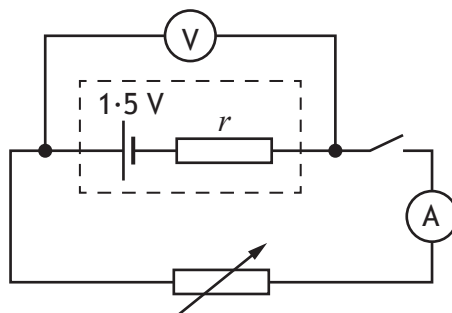

- (a) Describe how the student would use this apparatus, and analyse the data obtained, to determine the value for the internal resistance of the cell.

3



14. (continued)

MARKS  
DO NOT WRITE IN THIS MARGIN

- (b) The internal resistance of the cell is determined to be  $0.50 \Omega$ .  
Four identical cells are now connected to a motor and a variable resistor as shown.  
The EMF of each cell is  $1.5 \text{ V}$ .

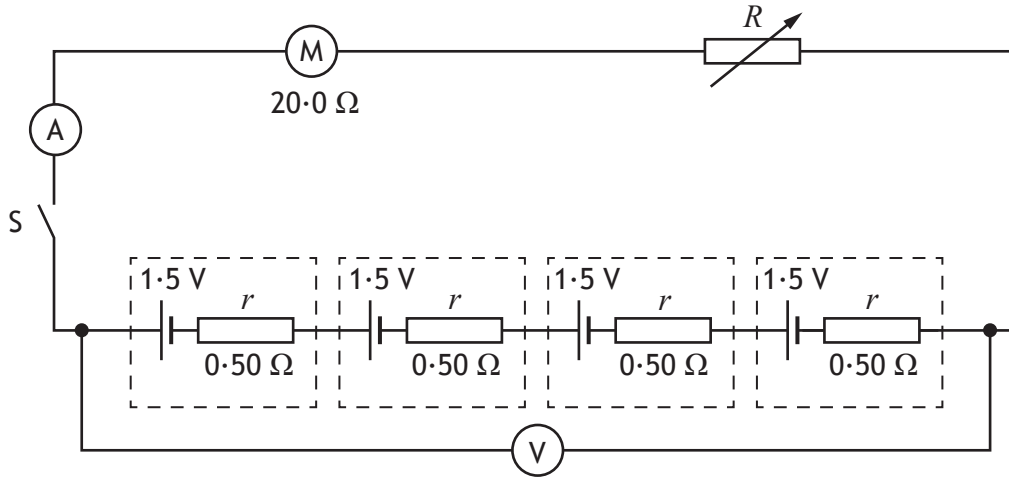

- (i) State what is meant by an EMF of  $1.5 \text{ V}$ . 1
- (ii) Switch S is now closed. The reading on the ammeter is  $0.20 \text{ A}$ .  
Determine the resistance  $R$  of the variable resistor. 4  
*Space for working and answer*



MARKS

DO NOT  
WRITE IN  
THIS  
MARGIN

14. (continued)

- (c) The resistance of the variable resistor is now increased.  
State what happens to the reading on the voltmeter.  
Justify your answer.

3



\* X 8 5 7 7 6 0 1 3 8 \*

15. A student carries out an experiment to measure the terminal velocity of ball bearings with different diameters falling through glycerol. Each ball bearing is dropped into a long tube filled with glycerol.

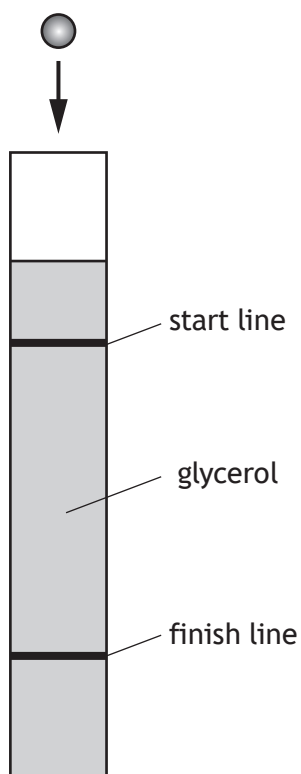

- (a) Explain in terms of the forces acting on the ball bearing, why it reaches its terminal velocity.

2

[Turn over



15. (continued)

MARKS

DO NOT  
WRITE IN  
THIS  
MARGIN

- (b) The student measures the diameter  $d$  of each ball bearing and records the corresponding terminal velocity  $v_t$ .

The results are shown in the table.

$d$ (m)	$d^2$ (m <sup>2</sup> )	$v_t$ (m s <sup>-1</sup> )
$3.15 \times 10^{-3}$	$0.99 \times 10^{-5}$	0.05
$4.77 \times 10^{-3}$	$2.28 \times 10^{-5}$	0.10
$6.34 \times 10^{-3}$	$4.02 \times 10^{-5}$	0.18
$9.52 \times 10^{-3}$	$9.06 \times 10^{-5}$	0.32
$12.65 \times 10^{-3}$	$16.00 \times 10^{-5}$	0.52

- (i) Using the square-ruled paper on *page 42*, draw a graph of  $v_t$  against  $d^2$ . 3  
 (The table of results is also shown on *page 43*, opposite the square-ruled paper.)
- (ii) The student suspects that the results show that there is a systematic uncertainty in the measurements. 1  
 Suggest a reason why the student has come to this conclusion.
- (iii) Calculate the gradient of your graph. 2  
*Space for working and answer*



\* X 8 5 7 7 6 0 1 4 0 \*

15. (b) (continued)

(iv) The terminal velocity  $v_t$  of each ball bearing is given by

$$v_t = \frac{375g}{\eta} \times d^2$$

where  $\eta$  is the viscosity of the glycerol in pascal seconds (Pa s)

$d$  is the diameter of the ball bearing in m

$g$  is gravitational field strength on Earth in  $\text{N kg}^{-1}$ .

Use the gradient of your graph to determine the viscosity of the glycerol.

2

*Space for working and answer*

[END OF QUESTION PAPER]



\* X 8 5 7 7 6 0 1 4 1 \*

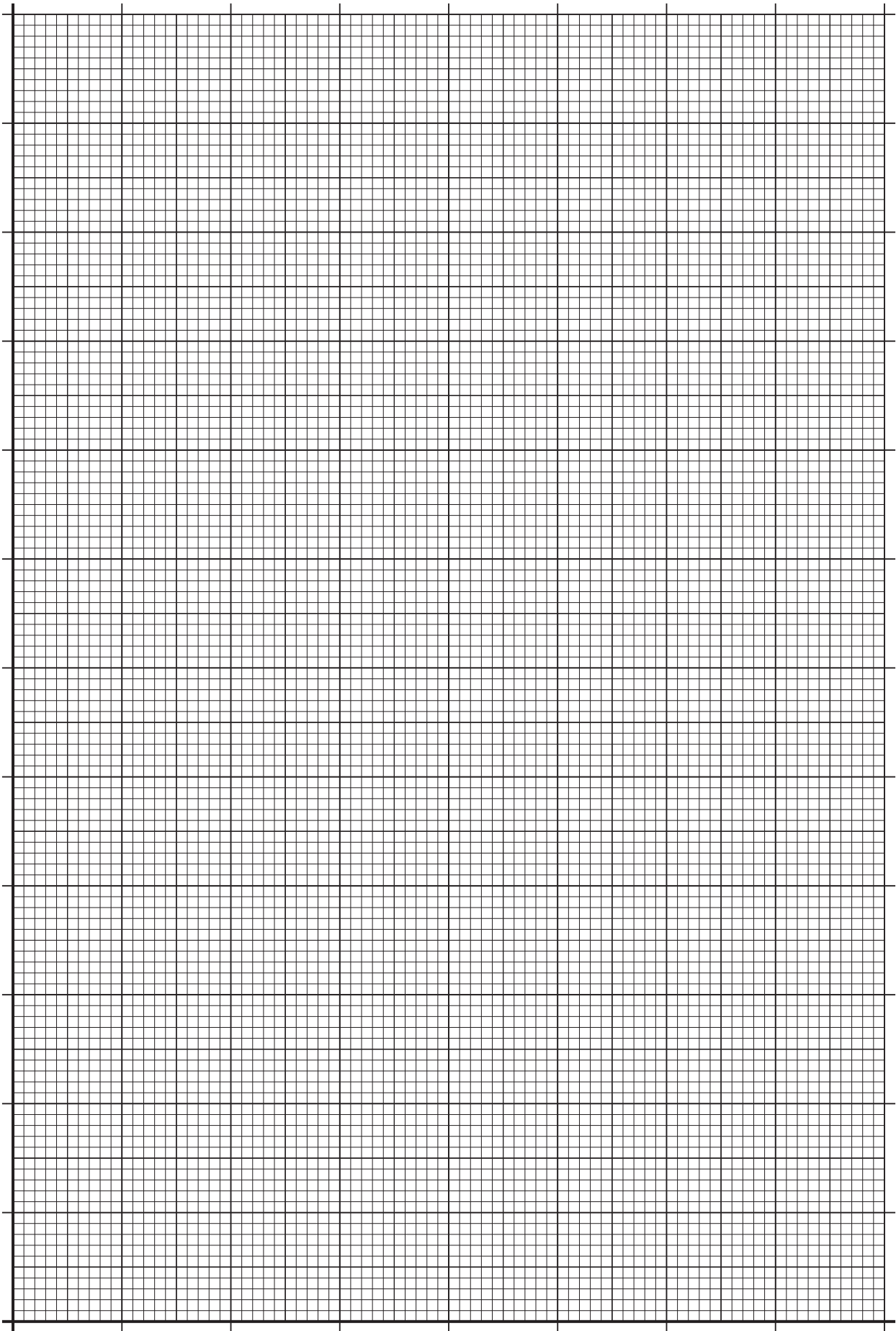

\* X 8 5 7 7 6 0 1 4 2 \*